



- Robuste Ausführung
- Gehäuse M30
- Messwege 2, 5, 10, 20 mm
- Schutzart IP65 (opt. IP68)
- Kontaktlos, verschleissfrei
- indiv. Ausführungen
  
- *For rough environment*
- *Housing M30*
- *Strokes 2, 5, 10, 20 mm*
- *Protection degree IP65 (opt. IP68)*
- *Contactless, wear free*
- *Individual designs*

LVDT Wegsensoren arbeiten nach dem Prinzip des Differentialtransformators.

*The displacement sensors operate according to the principle of the differential transformer.*

### Anwendungen:

- Weg- und Positionserfassung
- Industrie- und Medizintechnik
- Maschinen- und Anlagenbau
- Landwirtschaft, Schifffahrt
- Test- und Prüfeinrichtungen
- Sondermaschinenbau
- uvm.

### Applications:

- Displacement- and Position detection
- Industry und Medical Engineering
- Machine and plants design
- Agriculture, Navy
- Testing facilities
- Special machine design
- etc.

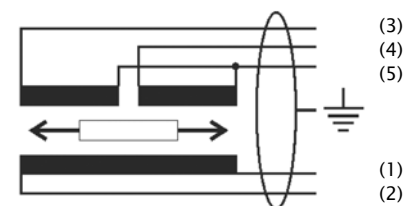

Prinzip des Differentialtransformators  
*Principle of the differential transformer*

### Optionen / Options

- Bessere Linearitätstoleranz / *Improved linearity tolerance*
- Erweiterter Temperaturbereich / *Extended temperature range*
- Schutzart IP67, IP68 / *Protection degree IP67, IP68*
- Individuelle Kalibrierungen / *Individual calibration service*
- Andere Kabellänge auf Anfrage (Standard = 1 m) / *Other cable length on request (standard = 1 m)*
- Weitere Optionen auf Anfrage / *More options on request*

Elektrische Spezifikation / <i>Electrical Specification</i>					
Messweg <i>Stroke</i>	±1	±2,5	±5	±10	[mm]
Empfindlichkeit <i>Sensitivity</i>	130	105	60	40	[mV/V/mm]
Linearitätstoleranz <i>Linearity tolerance</i>	< ±0,5 (optional < ±0,25)		< ±0,5		[% F.S.]
Erregerspannung <i>Supply voltage</i>	1..5				[V RMS]
Erregerfrequenz <i>Supply frequency</i>	1..20				[kHz]
Primärwiderstand <i>Input resistance</i>	75				[Ohm]
Primärimpedanz <i>Input impedance</i>	610				[Ohm]
Ausgangsimpedanz <i>Output impedance</i>	520				[Ohm]
Temperaturkoeffizient <i>Temperature coefficient</i>	<±0,05				[% F.S./°C]
Kalibrierung bei <i>Calibrated supply</i>	3V RMS / 20 kHz / RL=1MOhm				

Mechanische Spezifikation / <i>Mechanical Specification</i>		
Gehäusematerial <i>Housing material</i>	Stahl blau verzinkt <i>steel blue zinc-plated</i>	
Kernmaterial <i>Core material</i>	Nickel-Eisen-Legierung <i>Nickel-iron-alloy</i>	
Gewicht (mit Stecker) <i>Weight (with Plug)</i>	ca. 200	[g]
Gewicht Kern <i>Weight core</i>	ca. 1,5	[g]

Umgebungsbedingungen / <i>Environments</i>		
Nenntemperatur <i>Operation temperature</i>	-25..+85	[°C]
Lagertemperatur <i>Storage temperature</i>	-40..+85	[°C]
Schutzart <i>Protection degree</i>	IP65 (optional IP67, IP68) Steckerversion: mit montiertem Stecker <i>Connector version: with mounted connector</i>	
Schock <i>Schock</i>	200 g, 2ms	
Vibration <i>Vibration</i>	10g / 2 Hz .. 2 kHz	

### Anschlussbelegung / Connection (Kabellänge 1 Meter) (Cable length 1 meter)

Kabelfarbe <i>Colour of cable</i>	Für Steckeranschluss <i>For plug connection</i>	Signal <i>Signal</i>
weiß <i>white</i>	PIN 1	Primär 1 <i>Primary 1</i>
braun <i>brown</i>	PIN 2	Primär 2 <i>Primary 2</i>
gelb <i>yellow</i>	PIN 3	Sekundär 1 <i>Secondary 1</i>
grün <i>green</i>	PIN 4	Sekundär 2 <i>Secondary 2</i>
grau <i>grey</i>	PIN 5	Sekundär 1, 2 Mitte <i>Secondary 1, 2 Centre</i>
Schirm <i>Shield</i>	Gehäuse <i>Housing</i>	Gehäuse <i>Housing</i>

### Maßzeichnung / Drawing

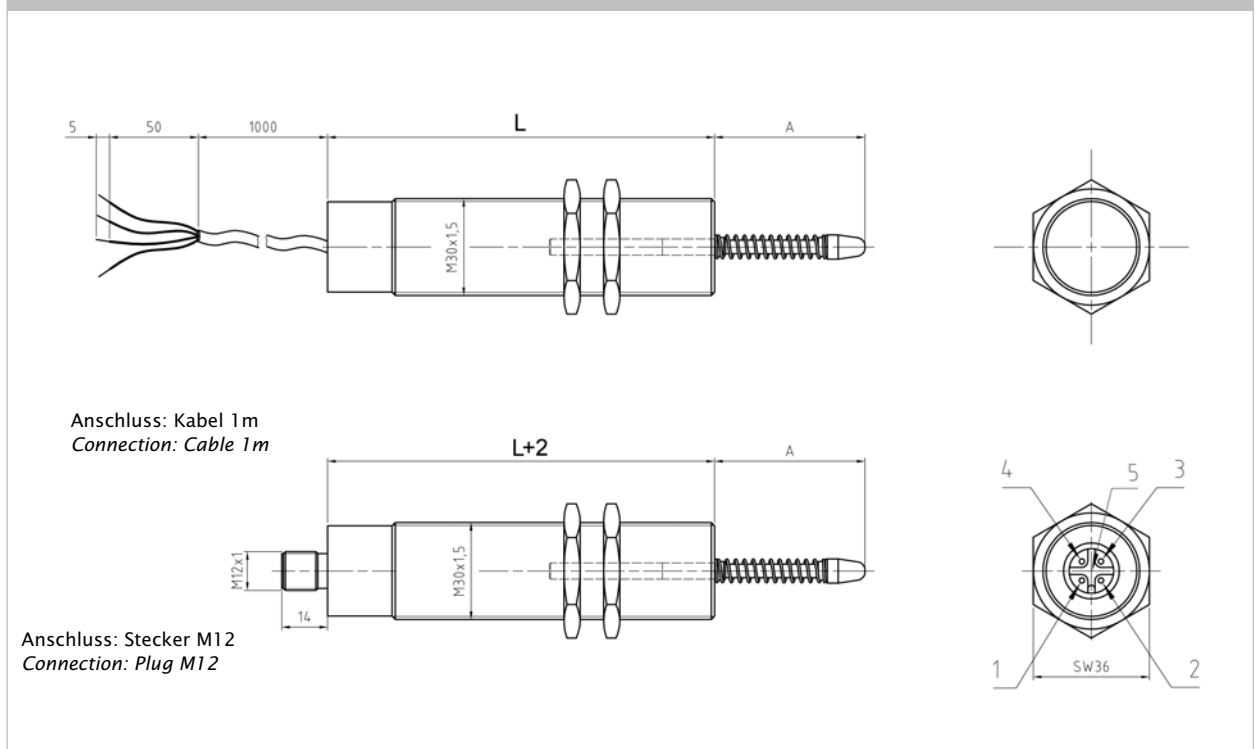

### Abmessungen / Dimensions



Messweg <i>Stroke</i>	±1	±2,5	±5	±10	[mm]
Mittelposition (A) <i>Middle position (A)</i>	19,5 ±1		22 ±1		[mm]
Zulässiger mechanischer Weg bezogen auf Mittelposition (A) <i>Acceptable mechanical stroke referring to middle position (A)</i>	±6			±11	[mm]
Gehäuselänge (L) <i>Housing length (L)</i>	64		95		[mm]

# Serie LVDT-IPAT



## Induktiver Wegsensor / *Displacement Sensor*

Bestellcode / Order code					
Serie Series	ohne Elektronik without electronics	Betätigung Operation	Messweg [mm] Stroke	Anschluss Connection	Lin.-Toleranz* Lin.-Tolerance*
IP-	A-	T-	10-	S-	
IP = Außengewinde M30 / external thread M30	A = AC	T = Taster Spring return	2 = ±1,0 mm 5 = ±2,5 mm 10 = ±5,0 mm 20 = ±10 mm	S = Stecker / plug K = Kabel / Cable 1m	*nur wenn < ±0,25% *in case of < ±0,25%
Optionen Options			Andere auf Anfrage Other on request	Andere Kabellänge / Other Cable lenght K2 = Länge 2m lenght 2m	

**Zubehör / Accessories**  PDF Download Document: 3159 [www.inelta.de/service](http://www.inelta.de/service)

	<b>Stecker mit Kabel (2m oder 5m)</b> Connector with cable (2m or 5m)		<b>Mutter /</b> Screw nut
--	--	--	------------------------------

**Sensorsignal-Verstärker / Signal Conditioner**  Datenblatt Datasheet [www.inelta.de](http://www.inelta.de)

			
Serie / Series	IMA2-LVDT	ISM-LVDT	IVM2-LVDT
Ausgangssignale / Output signals	0..5 V, 0..10 V, ±5 V, ±10 V, 0..20mA, 4..20 mA	0..10 V, 4..20 mA	0..10 V

**Applikationsbeispiele und Benutzerhinweise / Application directions and user guide**  PDF Download [www.inelta.de/service](http://www.inelta.de/service)

	<p><b>Die Broschüre zum Produkt mit Applikationsbeispielen und Benutzerhinweisen finden Sie im Internet unter <a href="http://www.inelta.de/service">www.inelta.de/service</a></b></p> <p><i>Suitable for this product you can download the brochure with application directions and user guides under <a href="http://www.inelta.de/service">www.inelta.de/service</a></i></p>
---	---

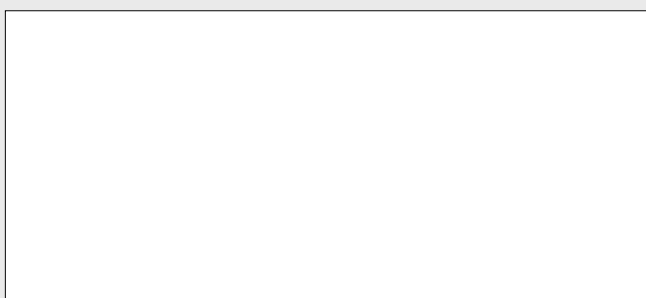

**inelta Sensorsysteme GmbH & Co.**

Haidgraben 9a  
D-85521 Ottobrunn/München

Phone +49 (0)89/45 22 45 -0

Fax +49 (0)89/45 22 45 -244

eMail: [mailbox@inelta.de](mailto:mailbox@inelta.de)

**[www.inelta.de](http://www.inelta.de)**